



[Ver.2026-04-03]

조명 기술 정보 안내

LIGHTING TECHNICAL INFORMATION

대학로예술극장

DAEHAKRO Arts Theater

소극장

Small Hall



CONTENTS

I. 전원 및 제어 시스템 Power & Control System

1. 전원 시스템 Power System
2. 제어 시스템 Control System

II. 조명기자재 현황 Light Equipment

1. 콘솔 Console
2. 무빙라이트 Moving Light
3. 일반조명기 General Light
4. 포그머신 Fog Machine
5. 악세서리 Accessory
6. 공용장비 Common Equipment

III. 조명 설치 장소 Lighting Hanging Position

무대 Stage

IV. 기타사항 Etc.

1. 컬러필터 리스트 Color Filter List
2. 무빙라이트 고보 리스트 Moving Light Gobo List
3. 기타 참고 사진 Other Reference Photo

I . 전원 및 제어 시스템 Power & Control System

1. 전원 시스템 Power System

- Dimmer System : **ADB EURODIM3 (180ea)** 220V/60Hz 5Kw
MA-VM(5ea) Auditorium Light
- Remote Direct : **Switch (17ea)** 220V/60Hz 5Kw

2. 제어 시스템 Control System

- Signal System : Universe – 4ea (XLR5pin)
 *A Port : Dimmer (Ch 1~180)
 House Light (Ch 201~205)
 Work Light (Ch 206~212)

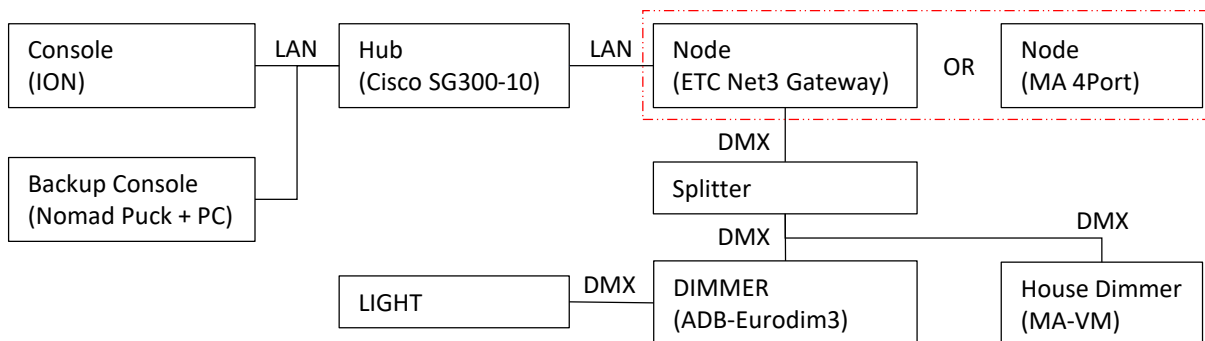



II. 조명기자재 현황 Light Equipment

1. 콘솔 Console

Item	Company	Model	Watt	Weight	Quantity	Remark
Main Console	ETC	Ion	240 w	9.2 kg	1	Ver.2.9.1
Backup Console		Nomad puck + PC	65 w	1 kg	1	

2. 무빙 라이트 Moving Light

Item	Company	Model	Watt	Weight	Angle	Q	Remark
LED	DTS	Nick 1201	450 w	14.5 kg	8° - 50°	15	Basic 20ch
	ETC	Source Four Series 2	171 w	8.4 kg	-	3	Only Body
Moving Spot	ETC	Halcyon Gold	684w	28.1 kg	6° - 57°	3	Standard 57ch

3. 일반조명기 General Light

Item	Company	Model	Watt	Weight	Angle	Q	Remark
Fresnel	MARUMO	FQB-1000WS1	1kw	5.7 kg	B 9°-24° F 20°- 37°	20	
		MSM805S1	1.5kw	6 kg	B 10°-22° F 19°- 52°	30	
PAR	KUPO	Par64	1kw	3 kg	B 7°-14° F 14°- 26°	52	
					B 12°-28° F 21°- 44°		
		Par46	250w	1 kg	-	55	1Set-8ea
		Body		-	-	69	
		19°		6.8 kg	B 15° F 18°	7	
		26°		6.8 kg	B 18° F 25°	10	
S-4	ETC	36°	750w	6.8 kg	B 27° F 34°	27	
		50°		6.8 kg	B 36° F 50°	41	
		70°		7.9 kg	B 60° F 70°	3	
		Zoom 25°~50°		7.6 kg	B 17°F 25° - B 33°F 50°	20	
Flood	MARUMO	QCU-2	500w	2.5 kg	-	10	



4. 포그 머신 Fog Machine

Item	Company	Model	Watt	Weight	Quantity	Remark
Fog Machine	KAI SHINE	LFA-T2	1,500 w	17.9 kg	1	Haze
	ANTARI	Z-1000 II	1,000 w	6.6 kg	1	Heavy
Fan		-			1	-

5. 악세서리 Accessory

Item	Company	Model	Spec	Quantity	Remark
Iris	ETC	Source Four	400RS	10	-
Stand	-	Low	65mm(H)	3	SHB-10
			150mm(H)	5	-
		Middle	985~1,685mm(H)	10	-
Barn Door	MARUMO	FQM 150S2	-	30	Fresnel 1kw or 1.5kw

6. 공용 기자재 Common Equipment

Item	Company	Model	Watt	Weight	Quantity	Remark
Foot Light	ASTERA	Pixel Brick	15 w	1.1 kg	1set (8ea)	Mode1~97 1~21ch
Strobe	PROLIGHT	Flood300FC	300 w	5.2 kg	6	Mode1~7 1~18ch
Fog Machine	ANTARI	Z-1520 RGB	1,500 w	10.4 kg	1	Mode1 8ch
T-pipe	-	-	400mm(W) X 1,000mm(H)		17	1,000mm Extension pipe 85EA
Boom Stand	-	-	4,000(H)		6	

*** 공연 전 장비의 사용 및 수량에 대해 반드시 극장 담당자와 협의 바랍니다 ***

**Please speak with the management
About the usage of equipment before the
performance.**

Technical Support Division Lighting Director

Phone NO : 82)-02-3668-0041

Chief Lighting Director

E-mail Address : stage8227@arko.or.kr

Ⅲ. 조명 설치 장소 Lighting Hanging Position

무대 Stage

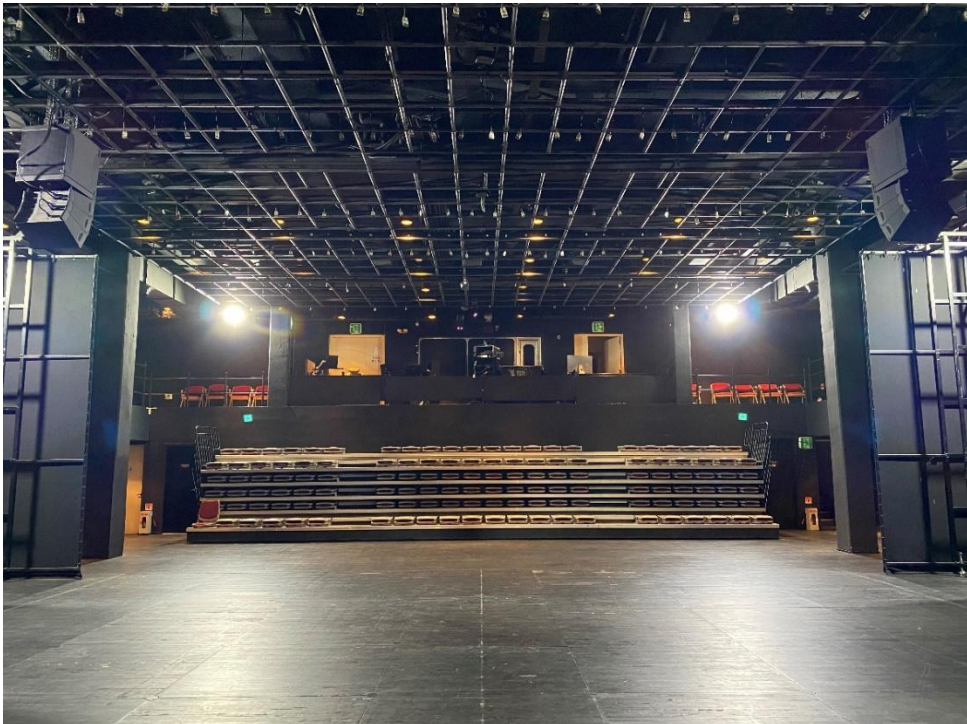

Grid Size(mm) 600 x 600 Pipe ϕ 480mm



IV. 기타사항 Etc.

1. 컬러 필터 리스트 Color Filter List







LEE FILTER

025	SUNSET RED	124	DARK GREEN	180	DARK LAVENDER
052	LIGHT LAVENDER	132	MIDIUM BLUE	181	CONGO BLUE
101	YELLOW	135	DEEP GOLDEN AMBER	197	ALICE BLUE
105	ORANGE	136	PALE LAVENDER	200	DOUBLE C.T. BLUE
106	PRIMARY RED	137	SPECIAL LAVENDER	201	FULL C.T. BLUE
111	DARK PINK	138	PALE GREEN	202	HALF C.T. BLUE
115	PEACOCK BLUE	147	APRICOT	203	QUARTER C.T. BLUE
117	STEEL BLUE	158	DARK ORANGE	204	FULL C.T. ORANGE
119	DARK BLUE	161	STATE BLUE	205	HALF C.T. ORANGE
121	LEE GREEN	162	BASTARD AMBER	228	BRUSHED SILK
122	FERN GREEN	165	DAYLIGHT BLUE	253	HAMPSHIRE FROST

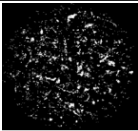
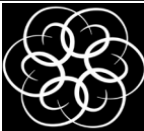
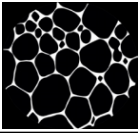
ROSCO FILTER

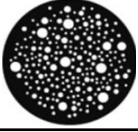
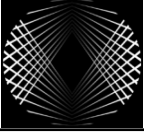
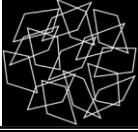
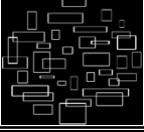
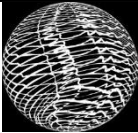
083	MEDIUM BLUE	085	DEEP BLUE		
114	HAMBURG FROST	119	LIGHT HAMBURG FROST	132	QUARTER HAMBURG FROST

2. 무빙라이트 고보 리스트 Moving Light Gobo List

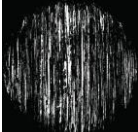
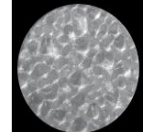
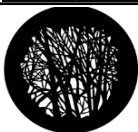
Halcyon Gold					
Fixed Gobo Wheel					
1		Texture Drops	5		Swing Gig
2		Lovely Bubbly	6		Stuco Leaves
3		Breakups GAM	7		The Only Way Is Up
4		Window Matrix	8		Repeater
Rotating Gobo Wheel					
1		Wiggle Lines	5		Stripes
2		Mycelium	6		Window
3		Bob's Brush	7		Ice
4		Branch Out			

3. 기타 참고 사진 Other Reference Photo

Stand



Total 8EA
Size(mm) 65(H), 150(H)



Total 10EA
Size(mm) 935~1,635(H)

Plug Type



2P&G(USA)

Ladder



Genie AWP-20S
1 EA
Size(mm) 6,120(H)
Max Weight 130kg



HIGHLOAD MS-4.7
1 EA
Size(mm) 6,400(H)
Max Weight 130kg